

427001254

Keep this manual so
that it is always to
hand for future use

EN **Drying cabinet**

User manual

Dear NIMO customer,

Congratulations on making an excellent choice of product, and welcome to the NIMO family, a global family with its roots in Sweden.

We at NIMO thank you for your trust and hope that you will enjoy using your new drying cabinet.

A good drying cabinet should be well designed, dry clothes well, have a low environmental impact, be user-friendly, save time and energy, have a long service life and be reliable. NIMO offers you all these features.

When you buy a NIMO product you can be sure that the inside is just as good as the outside and that the ethics and morals that go into building this product are just as high as the quality and function you are getting. That's what Swedish quality is all about.

Before using the product for the first time, please read the advice on using and caring for the product. This will help you get the best possible results from your product and all its functions.

If you have any questions, do not hesitate to call us or to contact us through our website.

Best wishes from Sweden and the NIMO team.

Article and serial number

See page 25

Manufacturer: NIMO-VERKEN AB
Box 124 S-548 22 HOVA
Tel +46 (0)506 / 488 00
Fax +46 (0)506 / 488 10
nimo@nimoverken.com
www.nimoverken.com



Art. No: 427001254 Rev 01

| | | | |
|--|-----------|--|-----------|
| THIS USER MANUAL | 4 | BREAKDOWNS IN OPERATION | 22 |
| SAFE OPERATION | 5 | OVERHEAT CUT-OUT: | 22 |
| DESCRIPTION OF THE DRYING CABINET | 6 | OPERATION EASY DRYER 1700F / 1900F | 24 |
| AIR FLOW IN THE DRYING CABINET | 7 | CONTROL PANEL | 24 |
| UNPACKING | 8 | CHOICE OF SETTINGS | 24 |
| PACKAGING MATERIALS | 8 | CARE | 25 |
| ASSEMBLY KIT | 8 | CLEANING | 25 |
| REHANGING OF DOOR | 9 | SERVICING | 25 |
| POSITIONING/SECURING | 10 | MANAGEMENT OF END-OF-LIFE DRYING CABINET | 26 |
| EVACUATION/SUPPLY AIR | 11 | TECHNICAL DATA SENSOR DRYER 1700F / 1900F | 27 |
| ELECTRICAL CONNECTION | 12 | TECHNICAL DATA EASY DRYER 1700F / 1900F | 28 |
| START-UP | 13 | TROUBLESHOOTING | 29 |
| ARRANGING LAUNDRY FOR DRYING | 14 | EASY DRYER | 29 |
| USER TIPS | 14 | SENSOR DRYER | 30 |
| AIR FLOW | 14 | LIST OF ERROR CODES SENSOR DRYER | 31 |
| OPERATION SENSOR DRYER 1700F / 1900F | 15 | DIMENSIONAL DRAWING | 32 |
| CHOICE OF AUTOMATIC PROGRAMME | 15 | | |
| CONTROL PANEL | 16 | | |
| START-UP OF THE DRYING CABINET WITH AUTOMATIC TIME CONTROL | 18 | | |
| STARTING THE DRYING CABINET WITH MANUAL TIME CONTROL | 19 | | |
| DOOR | 20 | | |
| ADJUSTMENT OF PARAMETERS AND CALIBRATION OF SENSORS | 20 | | |

THIS USER MANUAL

This user manual describes the drying cabinet's **function** and **operation** and contains instructions for **installation** and **maintenance**.



N.B. *Keep this manual so that it is always to hand for future use*

This advice on safe operation has been compiled to enable you to avoid incorrect use and unnecessary risks of accidents and should be read before the drying cabinet is installed and used.

CAUTION This equipment is intended only to be used to dry fabrics washed in water.

□ **Applicable to installation in the EU**

This drying cabinet can be used by children over the age of 8 and persons (including children) with various disabilities or inadequate experience and knowledge, provided they are kept under supervision or are given instructions on how to use the appliance in a safe way and understand the risks that use entails.

Children must not play with the appliance.

□ **Applicable to installation in countries outside the EU**

The appliance is not intended for use by persons (including children) with various disabilities or inadequate experience and knowledge.

They may use the appliance only under supervision or if they have received instructions on how to use the appliance from a person who is responsible for their safety.

Children must be supervised to ensure that they do not play with the appliance.

□ **Applicable to all installation**

CAUTION To avoid danger due to accidental resetting of the over-heat cut-out, this product must not be connected to an external switching device such as a timer or to a circuit that regularly turns the product on and off.

- If the power cord is damaged, it must be immediately replaced, and this must be done only by the manufacturer, the manufacturer's service agent or similarly qualified persons in order to avoid danger.

DESCRIPTION OF THE DRYING CABINET

The drying cabinet operates with hot air that removes moisture from the laundry. Heating and fan components are combined in the upper part of the drying cabinet behind the control panel.

The drying cabinet is available in two variants:

Easy Dryer, where the cabinet is controlled by two knobs, one for setting power modes and the other for adjusting drying time.

Sensor Dryer, where the cabinet has buttons for both automatic and manual setting of the drying process.

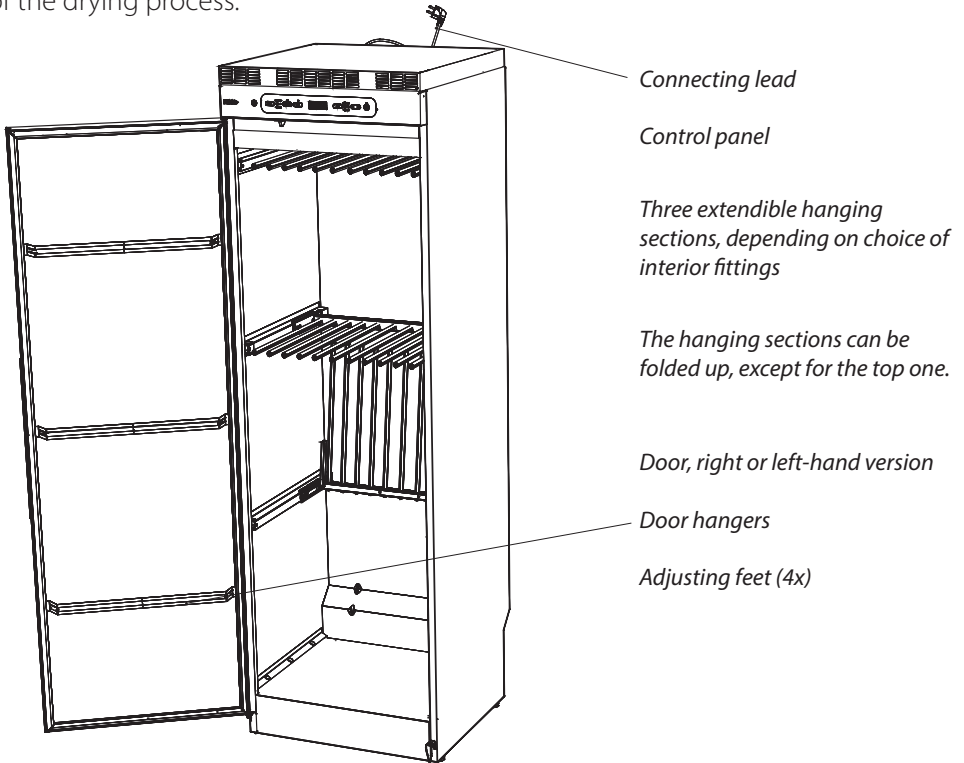

AIR FLOW IN THE DRYING CABINET

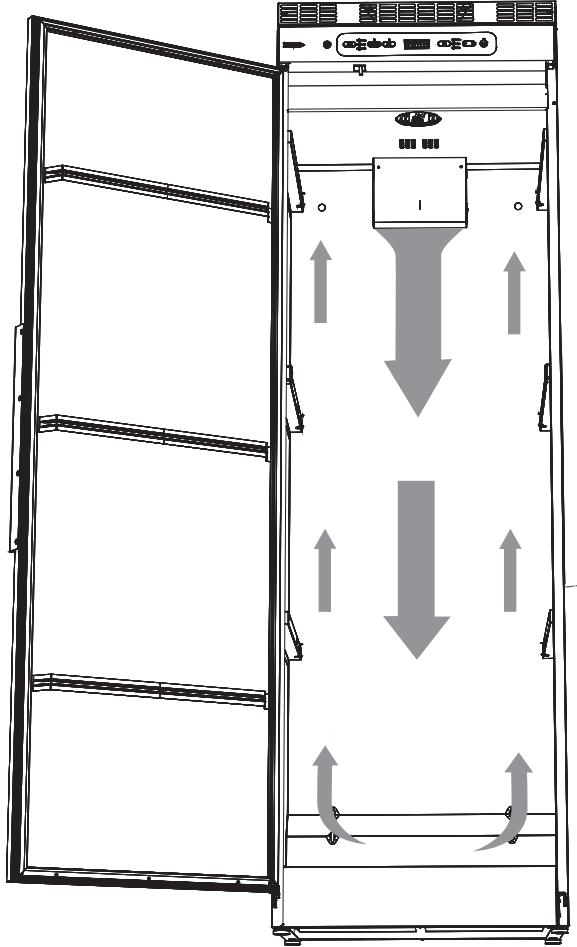

Note the direction of air flow inside the cabinet when positioning laundry. See also this section.

UNPACKING

PACKAGING MATERIALS

The packaging that protects the drying cabinet against damage in transit has been chosen with concern for the environment in mind and is therefore recyclable.

Packaging that is returned to the material cycle means reduced consumption of raw materials and a smaller volume of waste.



The drying cabinet must be handled carefully if it is standing unsupported on its pallet.

RISK OF TIPPING OVER





Check that the product has not been damaged in transit. Any damage incurred in transit must be reported to the dealer within 7 days.

After unpacking, check that the product is intact. Damage, defects and any missing parts must be reported to the dealer immediately.

A complete delivery must include:

- Cabinet with installed fan unit
- Assembly kit
- User manual

ASSEMBLY KIT

| | | |
|---|--------------------|----------|
|  | Screw TRX 5x70 fzk | Qty 2 |
|  | Washer NB 5x25 | 2 |
|  | Plastic plug | 2 |
|  | Spacer 8.2x12x15 | 2 |

REHANGING OF DOOR

The door may be right-hung or left-hung.

- 1 Lay the drying cabinet down on its side.
- 2 Detach the hinge pin at the lower hinge (1) and lift off the door. Retain the washer (3).
- 3 Detach the hinge pin at the upper hinge (2) and install it on the opposite side. The pin has a slot for a screwdriver.
- 4 Rotate the door, fit and screw in the door with the lower hinge pin (1) and the washer (3).

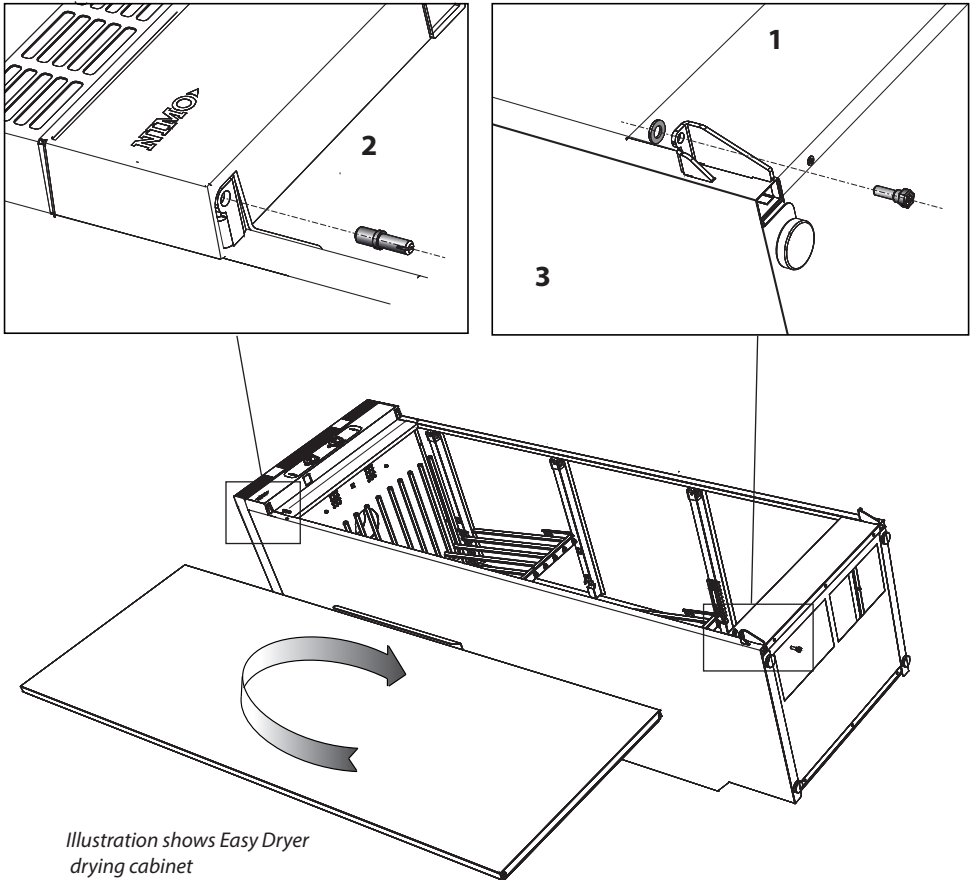

POSITIONING/SECURING

The drying cabinet is intended only to be positioned in a dry place indoors and to be secured to a wall.

The drying cabinet must not be positioned in an environment in which high-pressure water is used for cleaning.

The drying cabinet must be **level on a flat surface**, resting on all four feet.

If there is a need for adjustment, lean the cabinet and adjust the adjusting feet. Check with a spirit level that the cabinet is level.

Bear in mind that the cabinet is top-heavy and there is a risk of it tipping over. This adjustment should therefore be carried out by two people.

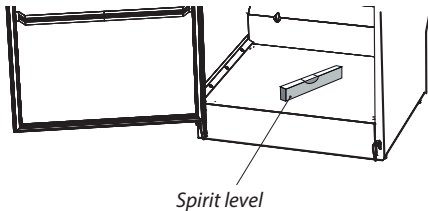

Securing to a wall also means a better door seal.

CAUTION *The drying cabinet must not be used without being secured to a wall owing to the risk that it might tip forward.*

- 1 Plastic plug
- 2 Wall behind drying cabinet
- 3 Spacer
- 4 Rear wall of drying cabinet
- 5 Fixing screw with washer

The cabinet must be **secured to a wall** to prevent tipping over.

- 1 Open the door and drill 8 mm holes in the wall through the two pre-drilled holes in the rear of the drying cabinet.
- 2 Fit the plastic plugs in the wall. Thread the spacer onto the screw and fit with a washer as illustrated. Screws are provided in the assembly kit.

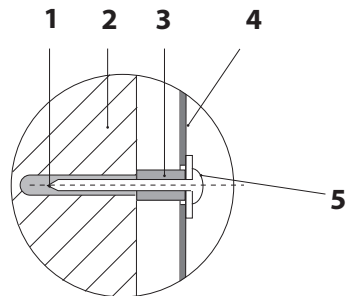
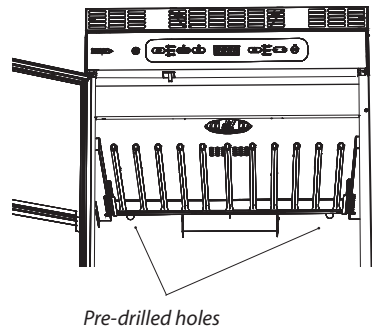

EVACUATION/SUPPLY AIR

The cabinet does not need to be connected to an evacuation duct, as air intake and ejection of moist air are located on the front of the cabinet.

The air intake must not be blocked.

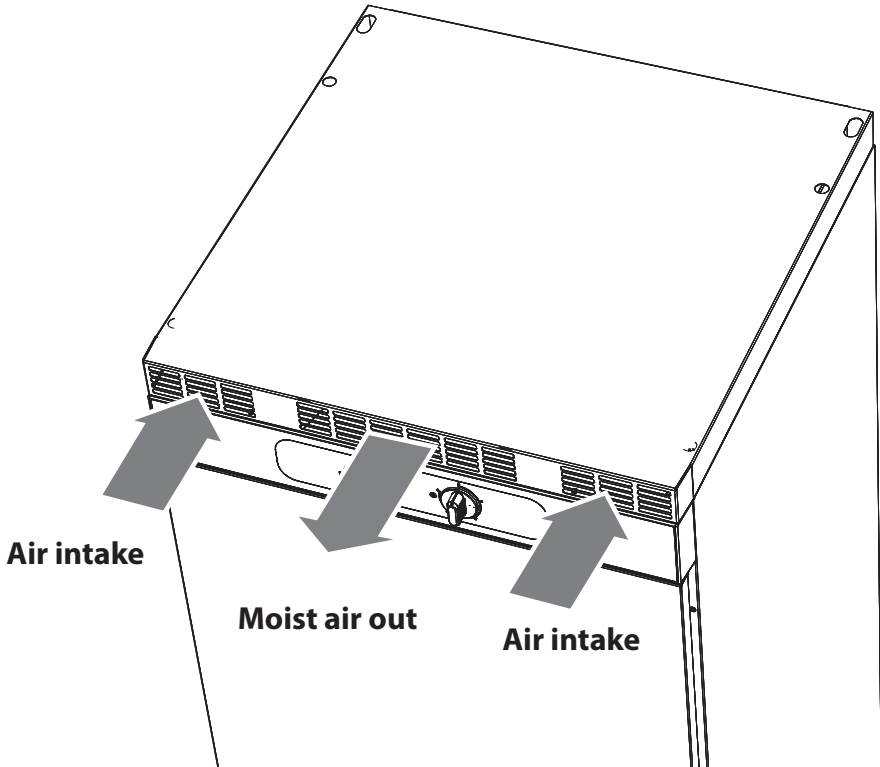

ELECTRICAL CONNECTION

The drying cabinet must be connected to a 230 V single-phase 50-60 Hz and protectively grounded wall socket.

Fuse 10A.

The drying cabinet should be connected to a grounded wall socket using the connecting cable supplied and must not be permanently wired.

The socket should be located so that the plug can be easily pulled out if necessary.

*Check that the connection current agrees with the data on the identification plate and that the power cord is grounded correctly in accordance with applicable standard. We recommend that the power cord be fitted with a **residual current device (RCD)**.*

The drying cabinet must be connected to a dedicated circuit.

The manufacturer disclaims all liability if the electrical connection has not been carried out in the way described in this user manual.

The drying cabinet is supplied ready for connection with a cable and a grounded plug.

If the mains lead for any reason is damaged, it must be replaced. A genuine spare part can be obtained from the dealer who supplied the cabinet.

N.B. *A replacement cord must be fitted only by a qualified electrician.*



Read these operating instructions before using the drying cabinet for the first time.

CAUTION *Read the safety instructions on page 5 before using the cabinet.*

- 1** Make sure that the cabinet is firmly secured to the wall. See page 10.
- 2** Make sure that no packaging material has been left behind.
- 3** Use a mild detergent with hot water and wash the inside and outside of the drying cabinet. Dry carefully. See also the *Care* section later in the manual.

ARRANGING LAUNDRY FOR DRYING

There are three sections with hangers in the cabinet, depending on choice of interior fittings. Each section has a number of rails for hanging laundry.

- ❑ Hang the items in the drying cabinet according to how much space they require - not according to their weight.
- ❑ For maximum drying efficiency, do not lay items flat on the upper hanger section.
- ❑ Position long items next to the walls of the cabinet and shorter items towards the centre of the cabinet. The most efficient drying results are achieved by hanging items in this way.
- ❑ Fold up the two bottom hanger sections if long items are to be dried.
- ❑ Hang gloves, caps, scarves and similar items on the hanger strips on the inside of the door.
- ❑ All the hanger sections are extendible to make it easier to hang laundry. The hanger sections must be in their inner position when the door is closed.
- ❑ Do not overload the drying cabinet. If you do, the laundry will become creased and dry unevenly. Instead, leave a space between the items if possible.
- ❑ If there is a risk of particular items shedding colour, free space should be left around them.
- ❑ Avoid drying heavy items of clothing together with lighter items as they have very different drying times.
- ❑ Dry knitted products flat. These are heavy when wet and will stretch unnecessarily if they are hung on a peg.

USER TIPS

- ❑ Always follow the washing instructions on the item of clothing if present.
- ❑ If a fabric conditioner or anti-static agent is used, follow the manufacturer's instructions for use of this product.
- ❑ Adapt the drying temperature in the cabinet for products that contain foam rubber or similar material. Follow the manufacturer's instructions closely for the washing and drying of such products.

AIR FLOW

The illustration shows the air flow in the drying cabinet.

Keep the area around the evacuation duct clear of dust and dirt.

See page 11.

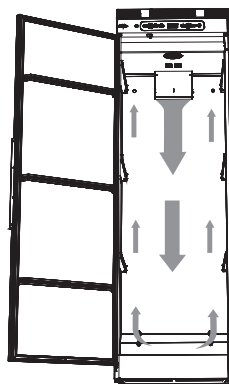

N.B. When the cabinet is cold it may happen that the door's sealing strip does not close completely. However, this is fully compensated when the cabinet is operated with heat as the sealing strip expands.

The drying cabinet is equipped with **three automatic programmes** and **three manually time-controlled programmes** suited to different types of clothing.

There are also extra functions for the automatic programmes.

The drying process is controlled by sensors or timer and temperature settings.

Choice of drying programme is guided by: - energy efficiency

- gentle treatment of fabrics
- dealing with fabrics that are difficult to dry
- total time for drying process

CHOICE OF AUTOMATIC PROGRAMME

When choosing automatic programme for the Sensor Dryer drying cabinet, you need to ask yourself some questions

1 WHEN MUST THE LAUNDRY BE DRY?

Can it wait for a long time? Or is it urgent?

Long time: choose ECO+, which is the cabinet's most energy-efficient programme.

Medium time: Choose between HIGH and LOW with the option ECO.

Short time: choose between HIGH and LOW.

2 WHAT TYPE OF FABRICS ARE THEY?

If they are tough fabrics, such as cotton, choose HIGH.

If they are sensitive fabrics, choose LOW.

If they are fabrics that are difficult to dry, such as children's overalls, choose Extra Dry for either HIGH or LOW.

3 WHY DOES THE CABINET NOT CLOSE BY ITSELF?

The cabinet is adjusted to a particular environment. If the environment in question differs from this reference environment, you may need to make some adjustment to the parameters controlling the drying process.

The procedure for setting is described in "Adjustment of parameters and calibration of sensor" on page 20.

OPERATION SENSOR DRYER 1700F / 1900F

CONTROL PANEL

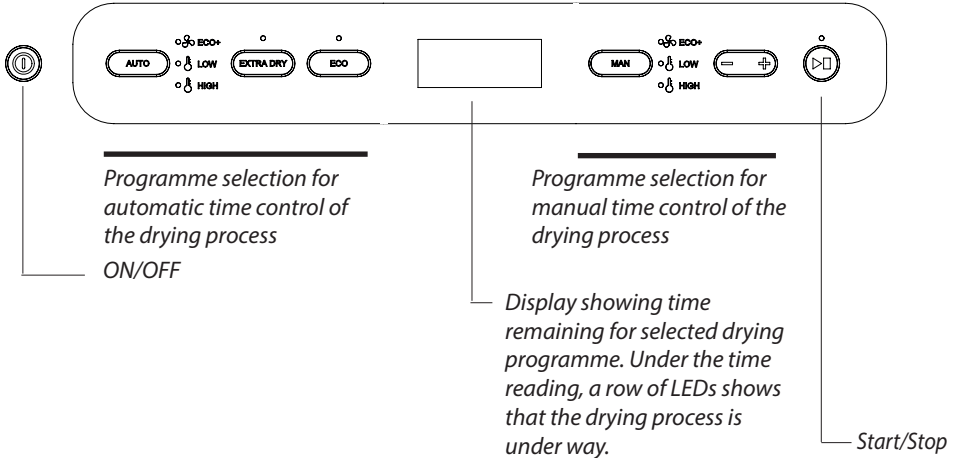

Buttons for automatic time control of the drying process



Button for activation of automatic drying process



Only the fan is started. This programme selection is highly energy-efficient and very gentle on the laundry. Use this programme when you have plenty of time. AUTO ECO now lights up.



Here both the fan and the element are active but have a limited temperature inside the cabinet. Use this programme when you need to get your sensitive fabrics dry in a shorter time. AUTO LOW now lights up.



Here both the fan and the element are active. The temperature limit is significantly higher than in AUTO LOW. This programme dries the fabrics quickly. AUTO HIGH now lights up.

You can choose an optional extra function, **EXTRA DRY**, for **AUTO LOW** and **AUTO HIGH**.

○



EXTRA DRY is for fabrics that are thicker and more difficult to dry, such as children's overalls, ski suits, etc. **AUTO HIGH** and **EXTRA DRY** or **AUTO LOW** and **EXTRA DRY** now light up.

In addition, there is an extra function, **ECO**, as an option for **AUTO HIGH**.

○



ECO is a programme that makes use of the thermal energy where it produces the greatest benefit. This results in a programme that is longer than the normal programme, but consumes less energy. If **AUTO ECO+** has been chosen as a drying programme as above, this function is already pre-selected. **AUTO HIGH** and **ECO** now light up.

Buttons for manual time control of the drying process



Button for activation of manual time control of drying process

○  **ECO+**

Only the fan is started. This programme selection is highly energy-efficient and very gentle on the laundry. Use this programme when you have plenty of time. **MAN ECO+** now lights up.

○  **LOW**

Here both the fan and the element are active but have a limited temperature inside the cabinet. Use this programme when you need to have your sensitive fabrics dry in a shorter time. **MAN LOW** now lights up.

○  **HIGH**

Here both the fan and the element are active. The temperature limit is significantly higher than in **MAN LOW**. **MAN HIGH** now lights up.

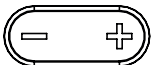

Reduces/Increases the manual drying time.

OPERATION SENSOR DRYER 1700F / 1900F

START-UP OF THE DRYING CABINET WITH AUTOMATIC TIME CONTROL



The cabinet is started by pressing **ON/OFF**.

The cabinet is activated by default with the previous programme selection active. If no programme has been selected previously or if the cabinet has been without power or is completely new, the cabinet is started in AUTO HIGH by default.

AUTO HIGH lights up and **Start/Stop** flashes.



If this is OK, start the cabinet by pressing **Start/Stop**.

The LED at Start/Stop stops flashing and is lit with a steady glow.

The estimated drying time is shown on the display, where the time is counted down. After the time has ended, the process stops automatically.

Selection of other automatic programme

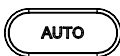

Select automatic programme by pressing the **AUTO button**.

Step through to the desired programme by pressing **AUTO** one or more times.



An extra function EXTRA DRY can be chosen in the AUTO LOW programme.



An extra function, EXTRA DRY or ECO, can be chosen in the AUTO HIGH programme.



Press **Start/Stop**. The LED is lit with a steady glow and shows that the process is under way.

STARTING THE DRYING CABINET WITH MANUAL TIME CONTROL



The cabinet is started by pressing **ON/OFF**.

The cabinet is activated with the previous programme selection active. If no programme has been selected previously or if the cabinet has been without power or is completely new, the cabinet is started in AUTO HIGH by default, i.e. an automatic programme.

Selection of manual programme



Select manual programme by pressing the **MAN button**.

Step through to the desired programme by pressing **MAN** one or more times.



The display shows a standard drying time which can be reduced or increased with the button.



Press **Start/Stop**. The LED is lit with a steady glow and shows that the process is under way.

The selected drying time is shown on the display, where the time is counted down. After the time has ended, the process stops automatically.

OPERATION SENSOR DRYER 1700F / 1900F

DOOR

Avoid opening the door while the drying process is under way as this prolongs the programme time. When the door is opened, the display shows **-P-**. You have 5 minutes in which to close the door before the cabinet turns the programme off completely and the cabinet has to be restarted.

ADJUSTMENT OF PARAMETERS AND CALIBRATION OF SENSORS

There are ways of optimising the automatic programmes of the drying cabinet for best possible results.

Adjustments must be made if it is found that:

- ▣ The laundry is not dried sufficiently.
- ▣ The laundry is over-dried – long drying time.

The sensors need to be re-calibrated for ECO+ to work optimally.

Calibrating sensors

N.B. It is important that the cabinet is at room temperature when calibrating.

To calibrate sensors, turn off the cabinet without any items of clothing hung inside, go to the parameter list, select parameter P400 and set it to the value 1. A calibration cycle that takes around 5 minutes will then start. When the sensors have been calibrated, the cabinet will re-start automatically.

Parameters to adjust

If the laundry does not feel dry, **increase** the parameter value for the programme-specific parameter

If the laundry feels over-dried, long drying time, **reduce** the parameter value for the programme-specific parameter.

See the table for the parameter of the programme concerned to be adjusted.

| PROGRAMME | Parameter |
|------------------|------------------|
| ECO+ | 2165 |
| LOW | 2233 |
| LOW EXTRA DRY | 2243 |
| HIGH | 2203 |
| HIGH EXTRA DRY | 2213 |
| HIGH ECO | 2273 |

Access to parameters

- 1 Turn off the cabinet by pressing **ON/OFF**.
- 2 Hold down **Start/stop** and then press **ON/OFF** again. Select parameter by stepping up or down using **-** and **+**.

Adjust parameters

- 1 When the desired parameter has been selected, press **Start/Stop** to go to the parameter concerned.
- 2 Adjust the parameter value by stepping down or up using **-** and **+**.
- 3 Press **Start/stop** to exit parameter adjustment.

Exit the parameter list

- 1 When you have adjusted the parameters you want, press **MAN** and **Start/Stop**.
- 2 If you wish to reset the parameters to the factory setting, press **AUTO** and **Start/Stop**

BREAKDOWNS IN OPERATION

OVERHEAT CUT-OUT:

The cabinet is equipped with an overheat cut-out. This trips when the temperature in the fan unit exceeds 120°C.

Sensor Dryer

When the overheat cut-out has tripped, the display and LEDs flash. The user can now reset the overheat cut-out by ***turning off the power supply with the switch inside the roof of the cabinet.***

See illustration.

The user has to wait for 10 to 15 minutes before the temperature has fallen and the overheat cut-out recloses. The power supply to the cabinet can then be turned back on using the same switch.

Easy Dryer

When the overheat cut-out has tripped, the cabinet is closed and the timer stops for example at 2 hours with the laundry wet. The user can now reset the overheat cut-out by ***turning off the power supply with the switch inside the roof of the cabinet.*** See illustration.

Alternatively, resetting can be done by turning the timer to zero.

The user has to wait for 10 to 15 minutes so that the overheat cut-out has time to reclose. The power supply to the cabinet is then turned back on using the same switch or by turning the timer back on.

BREAKDOWNS IN OPERATION

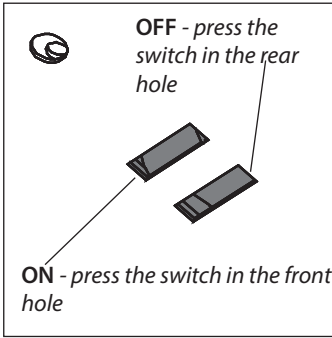

OFF - press the switch in the rear hole

ON - press the switch in the front hole

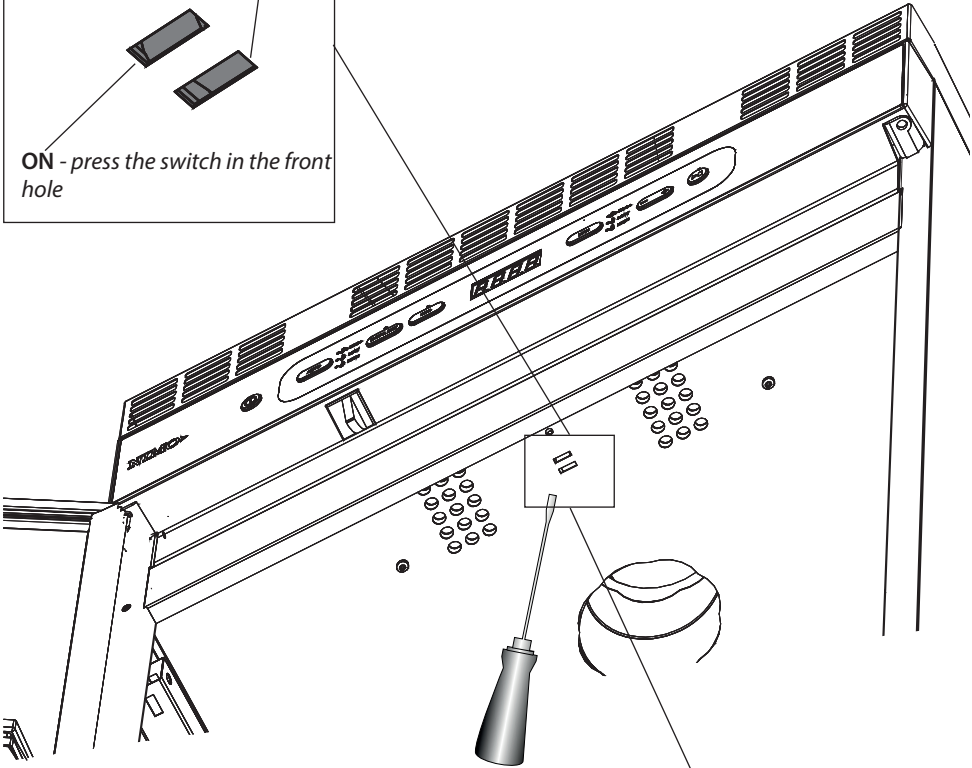

Toggle switch behind inner panel

Hole in inner panel for operation of the toggle switch with a screwdriver or similar tool

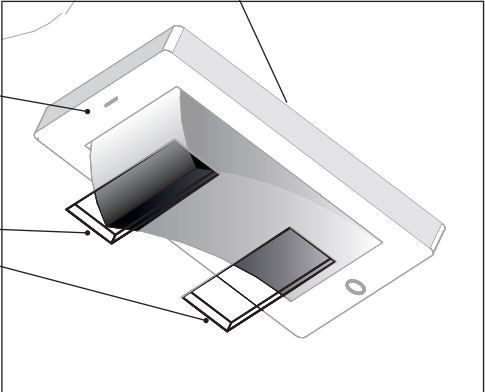

OPERATION EASY DRYER 1700F / 1900F

CONTROL PANEL

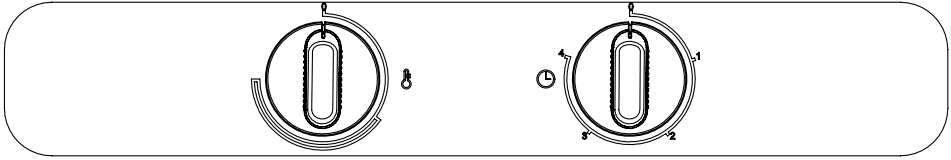

HEAT

DRYING TIME

The cabinet is equipped with two knobs for setting different power modes.

The left-hand knob regulates heat with power modes on a stepless scale.

The right-hand knob regulates drying time steplessly up to four hours.

CHOICE OF SETTINGS

High heat



If you want a fast drying result, and the item of clothing copes with HIGH heat, turn the heat knob to max and set the drying time at 1.5 to 2 hours.

Low heat



To dry at LOW heat, turn the heat knob to just after the start of the semi-circle and the drying time to between three and four hours.

CLEANING

N.B. Do not use high-pressure cleaning.

- ❑ Clean the walls of the cabinet with a mild soap solution on a damp cloth.
- ❑ Dust tends to collect around the air intake on the front of the cabinet. This can cause breakdowns, in turn leading to stoppages.

To avoid these problems, the air intake should be vacuumed at least once a year or more often depending on the environment the cabinet is located in.

SERVICING

Before contacting Service, you should find out the name, article number and serial number of the drying cabinet.

This information can be found on the drying cabinet located inside the cabinet.

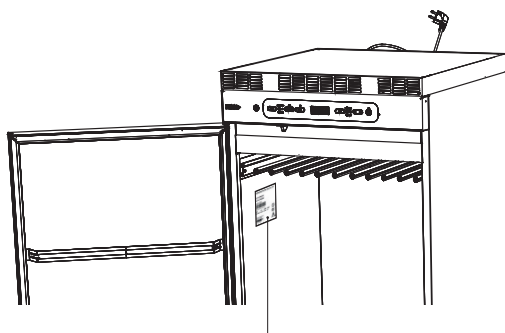

Identification plate (inside)

Illustration shows the Sensor Dryer drying cabinet

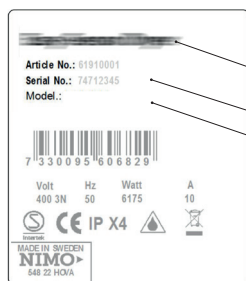

Name of the drying cabinet

Article number

Serial number (12 digits)

Follow NIMO instructions in repair and replacement of parts.

MANAGEMENT OF END-OF-LIFE DRYING CABINET

When the drying cabinet has reached the end of its useful life, it must be taken to a recycling centre for disposal. Many parts of the drying cabinet can be re-used, but it also contains other material that must be disposed of correctly. You should therefore never leave the drying cabinet or parts of the cabinet for collection with household waste, as this may pose risks to health and cause harm to the environment.

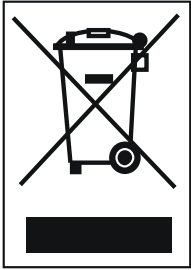

The end-of-life drying cabinet should instead be taken to a recycling centre. Check with your dealer if necessary.

All the plastic parts of the drying cabinet are marked with internationally standardised symbols. The parts of the drying cabinet can therefore be recycled in an environmentally sound manner by waste separation.

TECHNICAL DATA SENSOR DRYER 1700F / 1900F

| | |
|---------------------------------|---|
| Capacity: | Up to 6.0 kg laundry (cotton) |
| Dewatering capacity: | Up to 25 g/min |
| Electrical connection: | Single-phase 230 V, 50-60 Hz Fuse 10 A |
| Motor: | 38 W |
| Heating element output: | 2000 W |
| Overheat cut-out: | Yes |
| Fan capacity: | 184 m ³ /hour |
| Total hanging length: | 16 metres, depending on choice of interior fittings |
| Dimensions: | Height: 1750 / 1950 mm, Width 595 mm Depth 610 mm |
| Weight: | Sensor Dryer 1700F, 56 kg Sensor Dryer 1900F, 60 kg |
| Sound level: | max 55 dB(A) |
| Evacuated volume of air: | 95 m ³ moist air per hour |

ENERGY CONSUMPTION AND DRYING TIMES IN DRYING OF 4 KG OF SPUN LAUNDRY *)

| Programme | Energy consumption per kg dry laundry [kWh/kg] | Drying time *) [min] | Temp. max [°C] |
|---------------------|--|----------------------|----------------|
| AUTO ECO+ | 0.10 | 600 | Room temp. |
| AUTO LOW | 0.79 | 180 | 45 |
| AUTO LOW EXTRA DRY | 1.06 | 240 | 45 |
| AUTO HIGH | 0.64 | 85 | 70 |
| AUTO HIGH EXTRA DRY | 1.20 | 160 | 70 |
| AUTO HIGH ECO | 0.57 | 240 | 70 |

*) Values may vary depending on:

- spin speed
- temperature, air humidity in the room
- air circulation in the room (supply air, exhaust air)

MANUFACTURING STANDARDS

See cabinet identification plate

WIRING DIAGRAM

A wiring diagram can be ordered from the manufacturer.

TECHNICAL DATA EASY DRYER 1700F / 1900F

| | |
|---------------------------------|--|
| Capacity: | Up to 6.0 kg laundry (cotton) |
| Dewatering capacity: | Up to 25 g/min |
| Electrical connection: | Single-phase 230 V, 50-60 Hz Fuse 10 A |
| Motor: | 38 W |
| Heating element output: | 2000 W |
| Overheat cut-out: | Yes |
| Fan capacity: | 184 m ³ /hour |
| Total hanging length: | 16 metres, depending on choice of interior fittings |
| Dimensions: | Height: 1750 / 1950 mm Width 595 mm Depth 610 mm |
| Weight: | Easy Dryer 1700F, 56 kg Easy Dryer 1900F, 60 kg |
| Sound level: | max 55 dB(A) |
| Evacuated volume of air: | 95 m ³ moist air per hour |

ENERGY CONSUMPTION AND DRYING TIMES IN DRYING 4 KG SPUN LAUNDRY *)

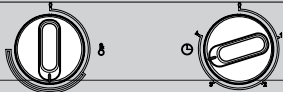
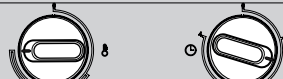
| Programme | Energy consumption per kg dry laundry [kWh/kg] | Drying time *) [min] | Temp. max [°C] |
|---|--|----------------------|----------------|
| Low temp.  | 0.67 | 220 | 35 |
| High temp.  | 0.69 | 90 | 65 |

*) Values may vary depending on:

- spin speed
- temperature, air humidity in the room
- air circulation in the room (supply air, exhaust air)

MANUFACTURING STANDARDS

See cabinet identification plate

WIRING DIAGRAM

Wiring diagram can be ordered from the manufacturer.

EASY DRYER

| Questions | What you can do |
|---|---|
| The drying cabinet is not working. | <ol style="list-style-type: none">1 Check that the mains lead is connected to a power socket and that power is supplied.2 Check that no fuse has tripped.3 Is the door closed?4 Check the toggle switch in the ceiling. See page 23. |
| Drying takes a long time. | <ol style="list-style-type: none">1 Make sure that the washing is not soaking wet (poorly spun).2 Check that too much laundry has not been hung. |
| The washing does not become dry. | Check that too much laundry has not been hung. |
| The sealing strip does not close tightly/the door is ajar | Check that the cabinet is level and secured to a wall. Check with a spirit level, adjust if necessary with the adjusting feet. |

TROUBLESHOOTING

SENSOR DRYER

| Questions | What you can do |
|---|---|
| The drying cabinet is not working. | <ol style="list-style-type: none">1 Check that the mains lead is connected to a power socket and that power is supplied.2 Check that no fuse has tripped3 Have you pressed the start button?4 Is the door closed?5 Check the toggle switch in the ceiling. See page 23. |
| The display shows an alarm/error code (Er1, Er2, Er3) | If an alarm or error code appears, first try to reset the alarm by holding the Start/Stop button down for 5 seconds. See section headed <i>"List of error codes for Sensor Dryer"</i> If the problem persists, call a service technician. |
| Drying takes a long time. | <ol style="list-style-type: none">1 Make sure that the correct programme has been selected for the type of washing.2 Make sure that the washing is not soaking wet (poorly spun).3 Check that too much laundry has not been hung.4 See the section headed <i>"Adjustment of parameters and calibration of sensors"</i> |
| The washing does not become dry. | <ol style="list-style-type: none">1 Make sure that the correct programme has been selected for the type of washing.2 Check that too much laundry has not been hung.3 See the section headed <i>"Adjustment of parameters and calibration of sensors"</i> |
| The sealing strip does not close tightly/the door is ajar | Check that the cabinet is level and secured to a wall. Check with a spirit level, adjust if necessary with the adjusting feet. |

LIST OF ERROR CODES SENSOR DRYER

| Error code | Cause |
|-------------------|--|
| Er 1 | Error 1 Regulator sensor. Error in the sensor at the element. The error is either a discontinuity or short-circuit in the sensor. Reset by disconnecting the power supply. |
| Er 2 | Error 2 Outlet sensor. Error in the sensor in the outlet duct. This error is the same as Error 1. Reset by disconnecting the power supply. |
| Er 3 | Error 3 The max time for the drying programme interrupts the drying process. Cause: The electronics has not received a signal from the outlet sensor that the laundry is dry. Reset by holding down the Start/Stop button for 5 sec. |

DIMENSIONAL DRAWING

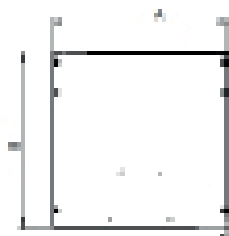
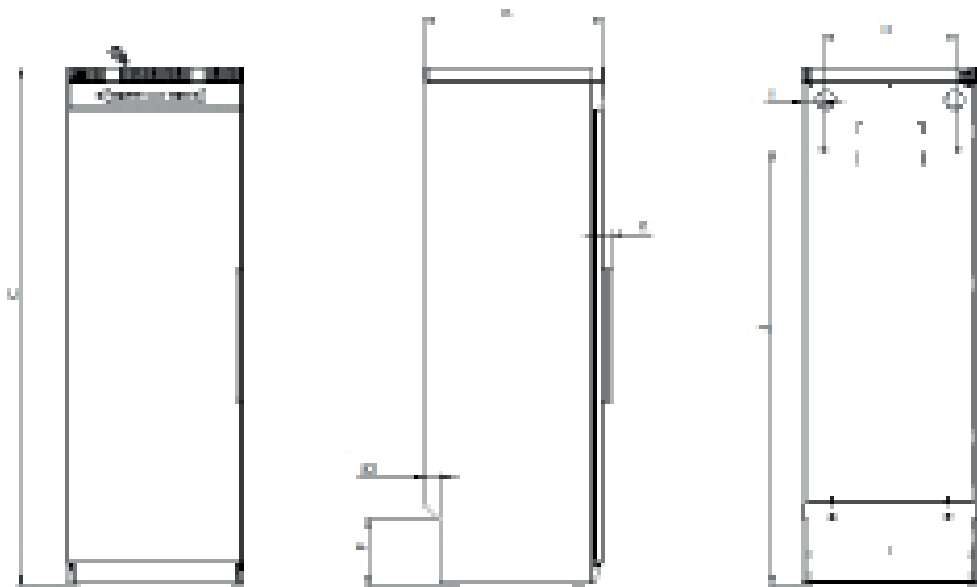

| | 1700F / 1900F |
|---|----------------------|
| A | 595 |
| B | 610 |
| C | 1750/1950 |
| D | --- |
| E | --- |
| F | 227 |
| G | 52 |
| H | 450 |
| I | 73 |
| J | 1474/1674 |
| K | 31 |
| L | --- |

